

Clippard

10 & 15 MM ELECTRONIC VALVES



10 & 15 mm Electronic Valves

10 mm Standard Series

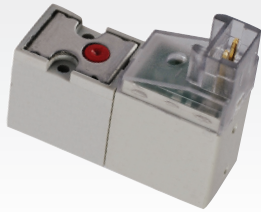

p. 4

Normally-open or normally-closed
2-way and 3-way

10 mm Latching Series

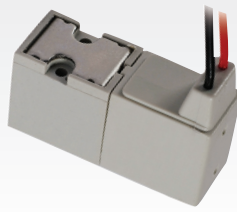

p. 6

Consume less energy
Produce less heat

10 mm High Flow Series

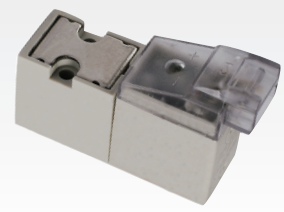

p. 8

High flow, low pressure
2-way

15 mm Standard Series

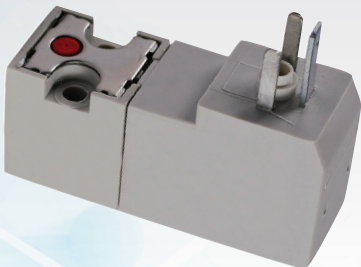

p. 14

Normally-open or normally-closed
2-way and 3-way

15 mm Latching Series

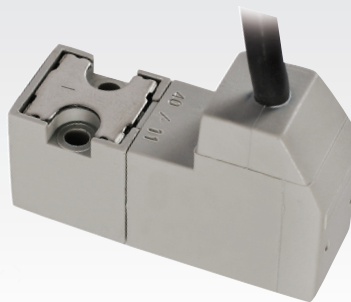

p. 16

Consume less energy
Produce less heat

15 mm High Flow Series

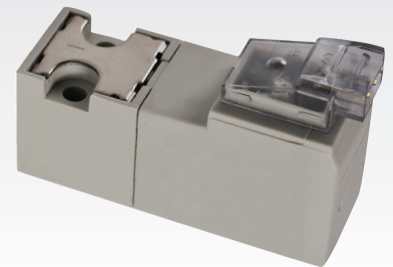

p. 18

High flow, low pressure
2-way

10 mm ISO Series

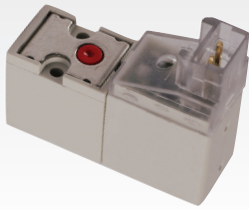

p. 10

ISO 15218 standard

Built-in hit and hold circuit

E2S Compact 10 mm Isolation Valve

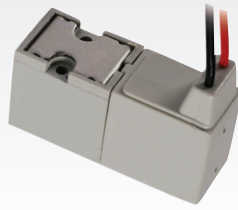

p. 12

Media isolation

EPDM diaphragm

CUSTOMIZATION OPTIONS

- Voltage
- Power
- Electrical Connectors
- IP Protection
- Pressures
- Manifold Assemblies
- Selector / Diverter
- Custom Seals

Contact Clippard for more details about how the 10 and 15 mm series valves can be customized to better meet the needs of your specific application.

Manifolds & Accessories

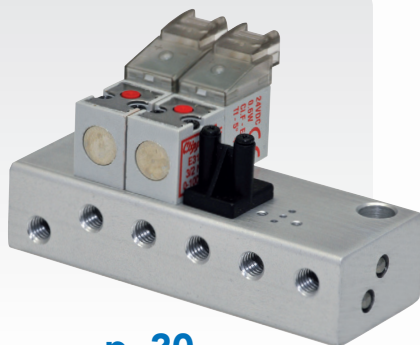

p. 20

Manifolds

Connectors and cover plates

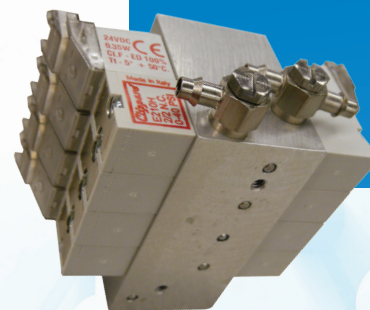
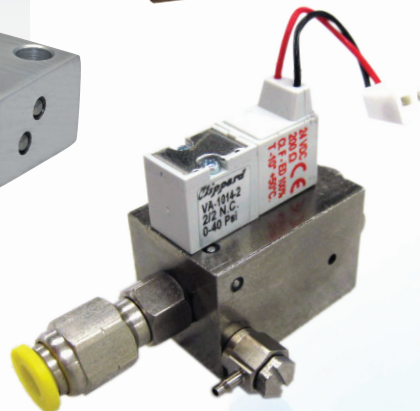

Scan the QR code or visit clippard.com/link/10-15mm-custom to easily configure your valve on our website.

10 MM STANDARD SERIES



Actual Size
10 mm
with 90° connector

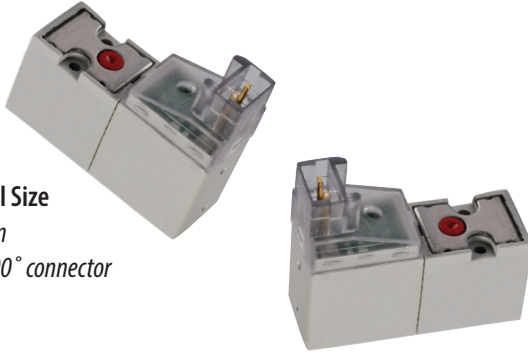

Clippard's 10 mm valves utilize plunger valve technology, a proven reliable design that is ideal for less demanding applications that require fast response times and relatively long life at a great price. Available in normally-open or normally-closed versions, these 2-way and 3-way valves feature a high strength, lightweight glass-filled nylon body and are suitable for a broad range of uses. This versatile miniature valve is a smart choice for applications across many different industries where compact, electronically-controlled pneumatics are needed.

TYPICAL FLOW

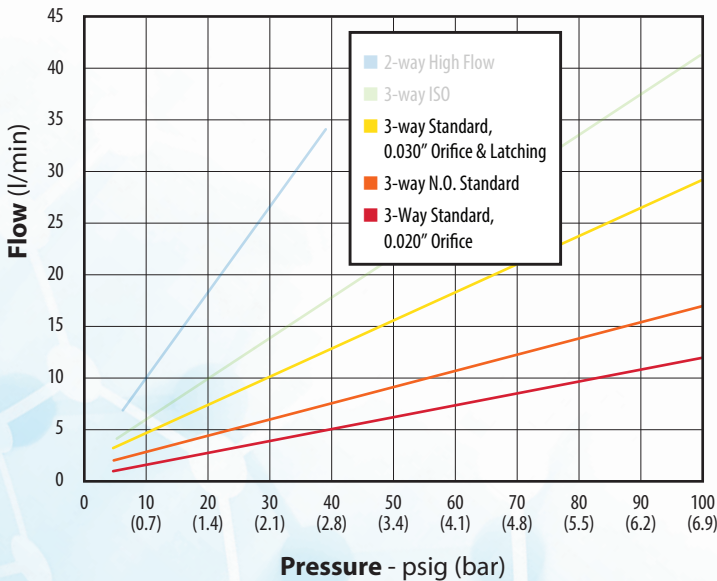

Coil Insulation Class	F 311°F (115°C)
Connector	In-Line Connector with LED 90° Connector with LED Wire Leads
Cycle Life	>50,000,000 (ideal applications)
Function	2-way normally-closed, 3-way normally-open or normally-closed
Manifold	Standard (See pp. 20-21 in brochure)
Material	Stainless steel core and springs, nylon body, ENP brass, FKM dynamic seals, nitrile gasket and static seals
Max. Flow	0.020" Orifice: 13 l/min @ 100 psig (7 bar) 0.030" Orifice: 30 l/min @ 100 psig (7 bar)
Medium	Air, gas, or other compatible fluids
Mount	M1.7 screws (x2)
Nominal Orifice Size	0.020" (0.5 mm), 0.030" (0.8 mm)
Operating Pressure Range	0 to 100 psig (7 bar) Consult Clippard for different pressures
Operating Temperature Range	14 to 122°F (-10 to 50°C) If below 32°F (0°C), must use clean, dry air
Power Consumption	0.6 or 1.3 watts Dependent on orifice size and pressure
Response Time	0.6 W: 10 ms nominal 1.3 W: 8 ms nominal
Voltage	12 or 24 VDC
Voltage Tolerance	±10%
More Details	clippard.com/link/10mm

Wire Leads

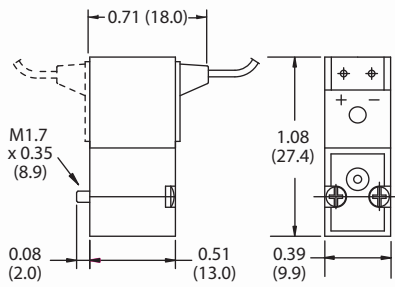

90° Connector with LED

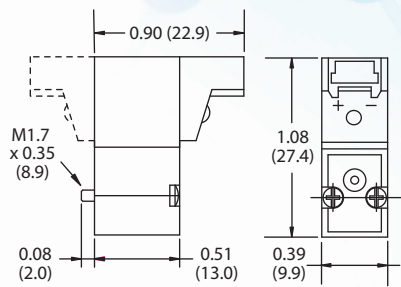

In-Line Connector with LED

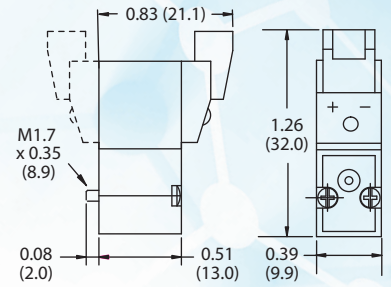

Suggested Manifold Dimension

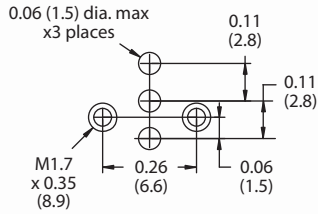

Pneumatic Interface

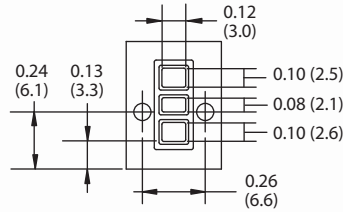

Dimensions shown are in inches
(millimeters listed in parentheses).

Visit clippard.com for more detailed
2D and 3D drawings.

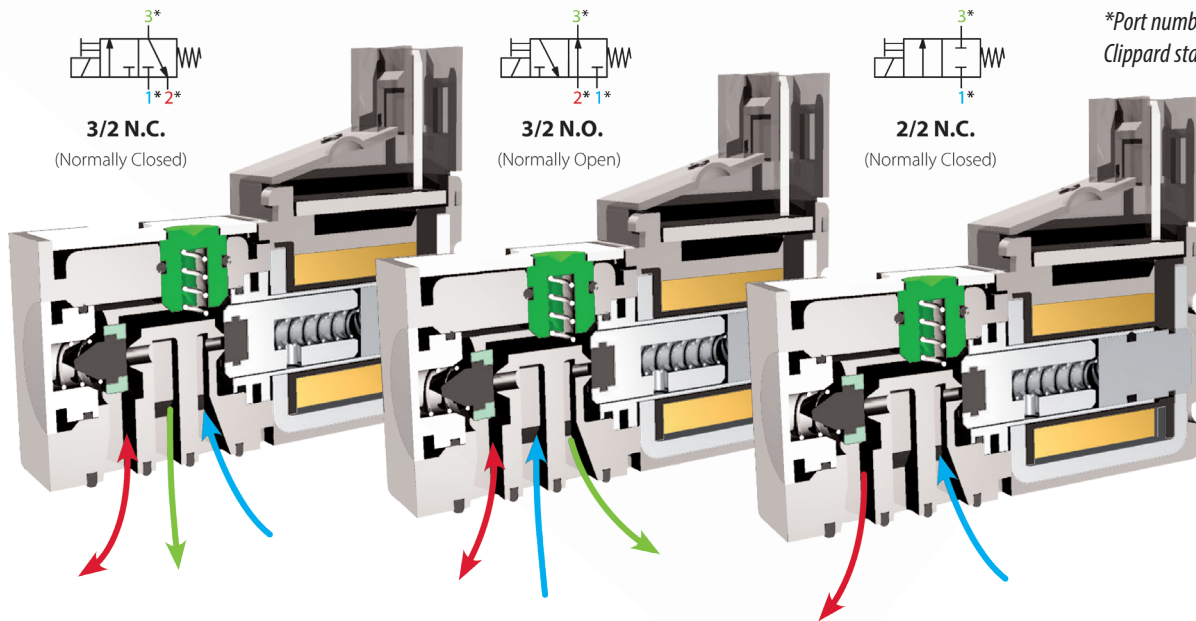

*Port numbers correspond to
Clippard standard manifolds

ORDERING INFORMATION

E	1	0	C	012
Valve Type	Orifice (mm) & Wattage		Connectors	Voltage
2 2-way	A-1 0.020" (0.5 mm) - 0.6 W		C In-line with LED	012 12 VDC
3 3-way	C-2 0.030" (0.8 mm) - 1.3 W		L 90° with LED	024 24 VDC
3O 3-way N.O.			W Wire Leads (11.8")	

Example Part Number:
E210A-1C012

For more info, scan the
QR code or visit
clippard.com/link/10mm



10 MM LATCHING SERIES

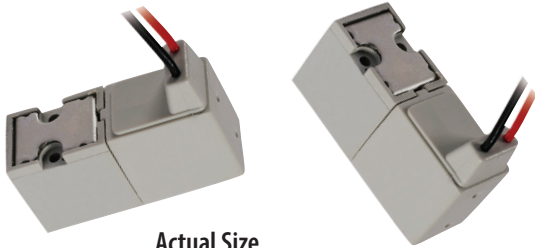

Actual Size
10 mm
with wire leads

Latching valves consume less energy and produce less heat than standard solenoid valves when used in extended duty cycle applications, since the coil is energized for only a small fraction of the total duty cycle. A short pulse of current opens the valve, which “latches” open indefinitely after the current stops. A subsequent pulse of current in the opposite direction closes the valve.

Coil Insulation Class	F 311°F (115°C)
Connector	Wire Leads
Function	2-way or 3-way normally-closed
Manifold	Standard (See pp. 20-21 in brochure)
Material	Stainless steel core and springs, nylon body, ENP brass, FKM dynamic seals, nitrile gasket and static seals
Max. Flow	30 l/min @ 100 psig (7 bar)
Medium	Air, gas, or other compatible fluids
Mount	M1.7 screws (x2)
Nominal Orifice Size	0.8 mm (0.030")
Operating Pressure Range	0 to 100 psig (7 bar) <i>Consult Clippard for different pressures</i>
Operating Temperature Range	14 to 122°F (-10 to 50°C) <i>If below 32°F (0°C), must use clean, dry air</i>
Power Consumption	2.0 watts
Response Time	10 ms nominal
Voltage	12 or 24 VDC
Voltage Tolerance	±10%
More Details	clippard.com/link/10mm

TYPICAL FLOW

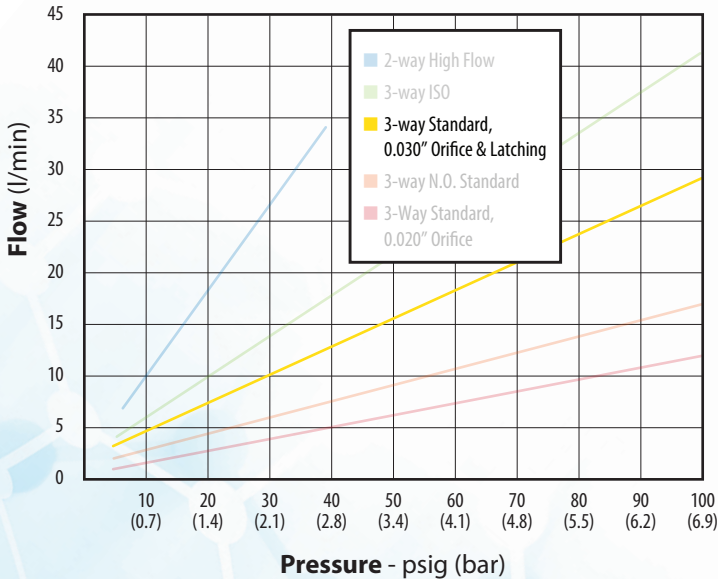

Wire Leads

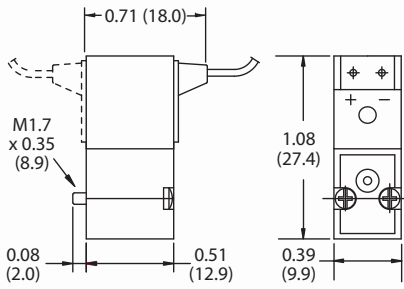

Suggested Manifold Dimension

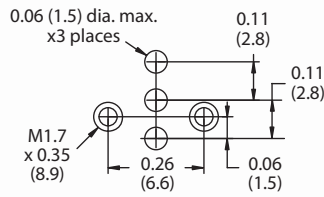

Pneumatic Interface

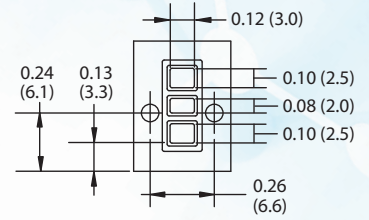

Dimensions shown are in inches (millimeters listed in parentheses).
Visit clippard.com for more detailed 2D and 3D drawings.

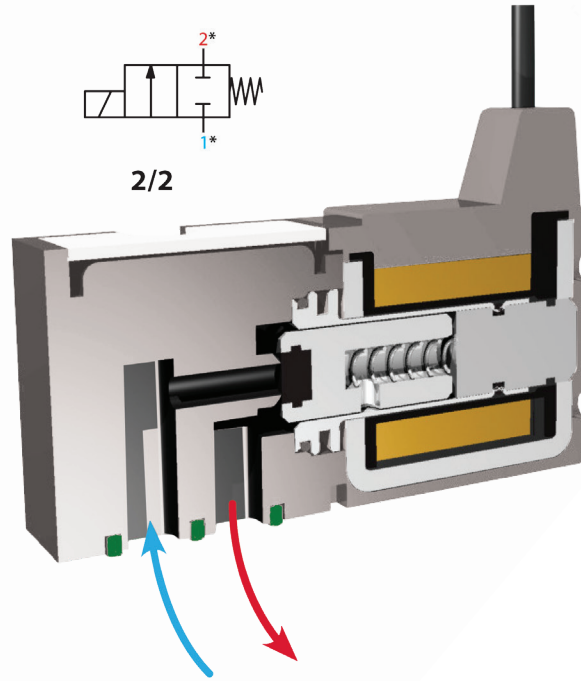
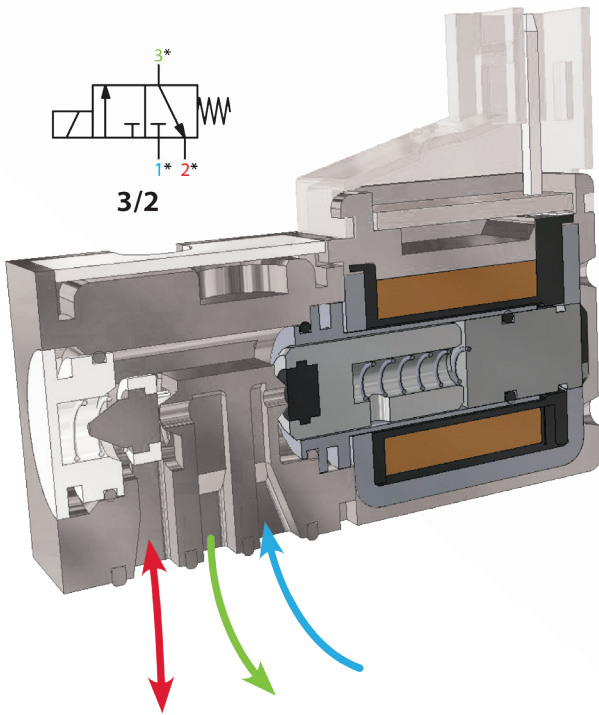

*Port numbers correspond to Clippard standard manifolds

Available Option (not standard)

ORDERING INFORMATION

E □ **L** **1** **0** **C** - **7** **W** □

Valve Type

- 2 2-way
- 3 3-way

Voltage

- 012 12 VDC
- 024 24 VDC

Example Part Number:
E2L10C-7W012

For more info, scan the QR code or visit
clippard.com/link/10mm



10 MM HIGH FLOW SERIES

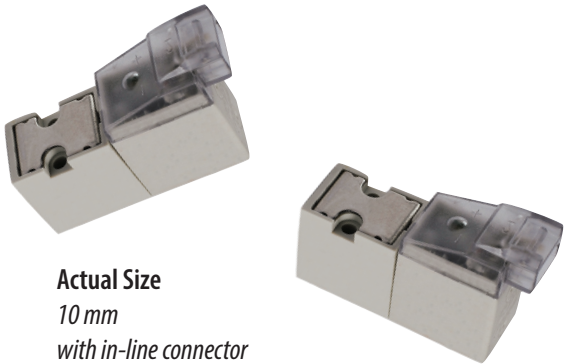

Actual Size
10 mm
with in-line connector

Clippard's high flow series valves are designed for high flow, low pressure applications. Available in normally-closed versions, these 2-way valves feature a high strength, lightweight glass-filled nylon body and are suitable for a broad range of uses. With exceptional cycle life and reliability, this versatile miniature valve is a smart choice for applications in many industries.

Coil Insulation Class	F 311°F (115°C)
Connector	In-Line Connector with LED 90° Connector with LED
Function	2-way normally-closed, bidirectional
Manifold	E10HM-01 (See pp. 20-21 in brochure)
Material	Stainless steel core and springs, nylon body, ENP brass, FKM dynamic seals, nitrile gasket and static seals
Max. Flow	35 l/min @ 40 psig (2.8 bar)
Medium	Air, gas, or other compatible fluids
Mount	M2 screws (x2)
Nominal Orifice Size	1.4 mm (0.055")
Operating Pressure Range	0 to 40 psig (2.8 bar) <i>Consult Clippard for different pressures</i>
Operating Temperature Range	14 to 122°F (-10 to 50°C) <i>If below 32°F (0°C), must use clean, dry air</i>
Power Consumption	3.5 watts in rush; 0.35 watts in maintenance phase
Response Time	10 ms nominal
Voltage	12 or 24 VDC
Voltage Tolerance	±10%
More Details	clippard.com/link/10mm

TYPICAL FLOW

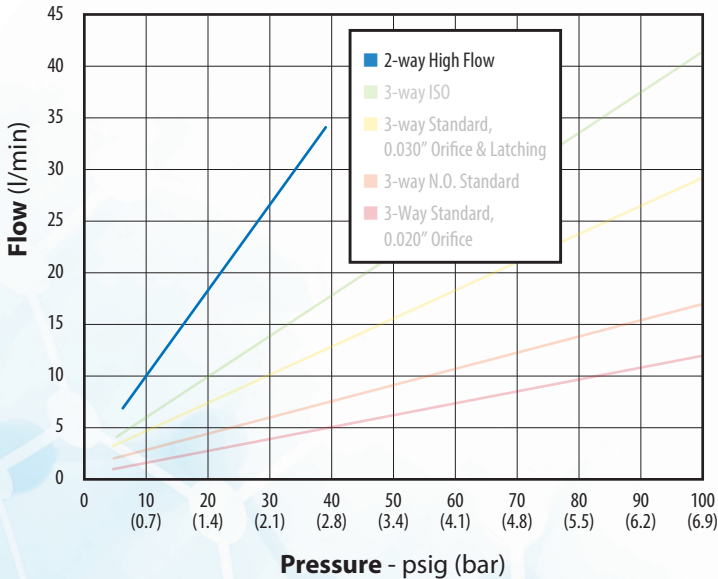

90° Connector with LED

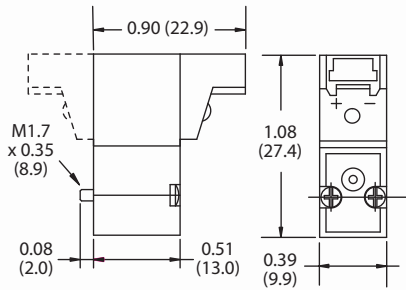

In-Line Connector with LED

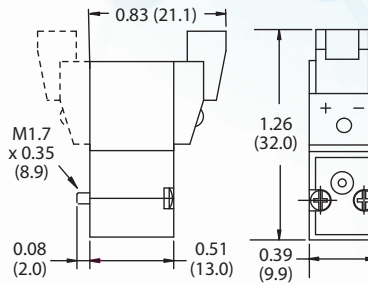

Dimensions shown are in inches
(millimeters listed in parentheses).

Visit clippard.com for more detailed
2D and 3D drawings.

Suggested Manifold Dimension

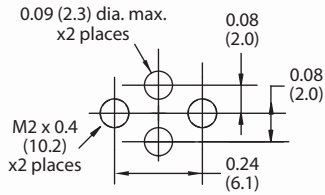

Pneumatic Interface

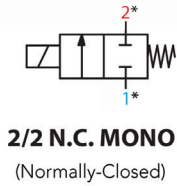
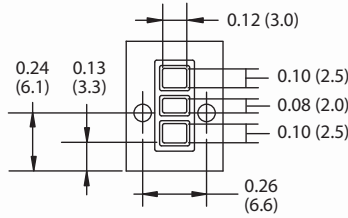

*Port numbers
correspond to
Clippard standard
manifolds

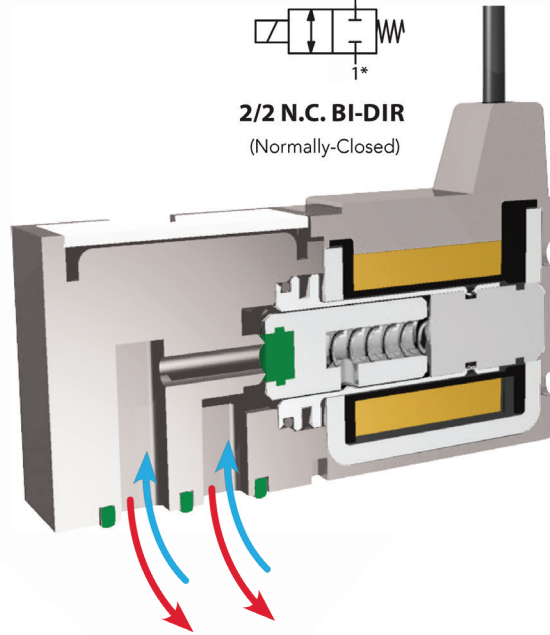
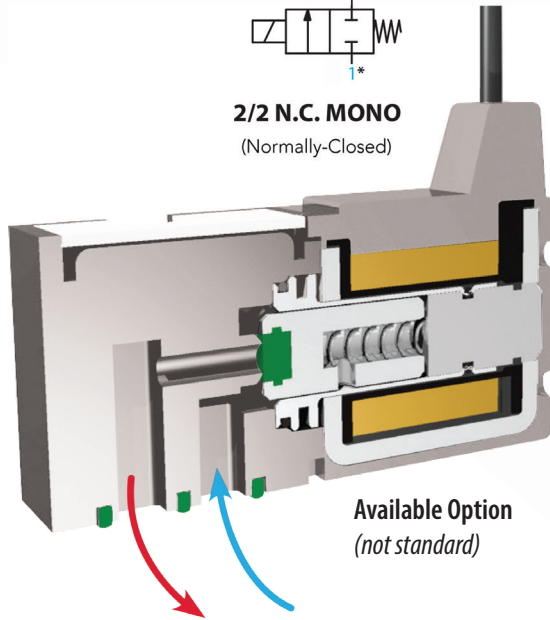

ORDERING INFORMATION

E 2 1 0 H - 3 □ □

Connectors

- C In-line with LED
- L 90° with LED

Voltage

- 012 12 VDC
- 024 24 VDC

Example Part Number:

E210H-3C012

For more info, scan the
QR code or visit
clippard.com/link/10mm



10 MM ISO SERIES



Actual Size
10 mm with 90° connector

Clippard's ISO Series valves are designed to conform to the ISO 15218 standard for mounting and port locations. This series also comes with a built-in hit and hold circuit which allows for a higher flow rate and lower holding power consumption than any of the other 10 mm valve series. With exceptional cycle life and reliability, the ISO Series is a smart choice for high performance applications.

Coil Insulation Class	F 311°F (115°C)
Connector	In-Line Connector with LED 90° Connector with LED
Function	3-way normally-closed
Manifold	E10LM-01 (See pp. 20-21 in brochure)
Material	Stainless steel core and springs, nylon body, ENP brass, FKM dynamic seals, nitrile gasket and static seals
Max. Flow	42 l/min @ 100 psig (7 bar)
Medium	Air, gas, or other compatible fluids
Mount	M 1.6 screws (x2)
Nominal Orifice Size	1.1 mm (0.043")
Operating Pressure Range	0 to 100 psig (7 bar) <i>Consult Clippard for different pressures</i>
Operating Temperature Range	14 to 122°F (-10 to 50°C) <i>If below 32°F (0°C), must use clean, dry air</i>
Power Consumption	3.5 watts in rush; 0.35 watts in maintenance phase
Response Time	6 ms nominal
Voltage	12 or 24 VDC
Voltage Tolerance	±10%
More Details	clippard.com/link/10mm

TYPICAL FLOW

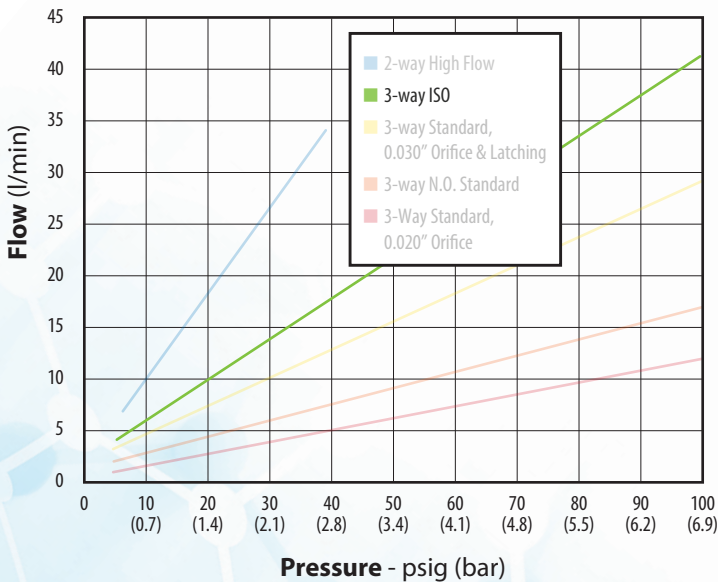

90° Connector with LED

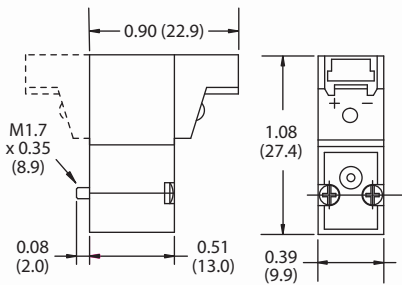

In-Line Connector with LED

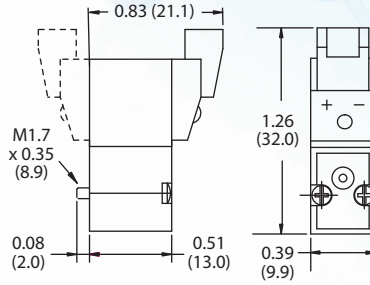

Dimensions shown are in inches
(millimeters listed in parentheses).

Visit clippard.com for more detailed
2D and 3D drawings.

Suggested Manifold Dimension

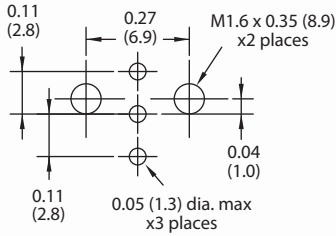

Pneumatic Interface

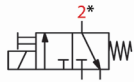
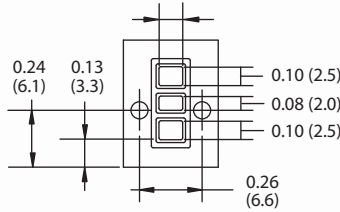

3/2 N.C.
(Normally-Closed)

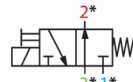

3/2 N.O.
(Normally-Open)

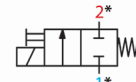

2/2 N.C.
(Normally-Closed)

*Port numbers correspond to
Clippard standard manifolds

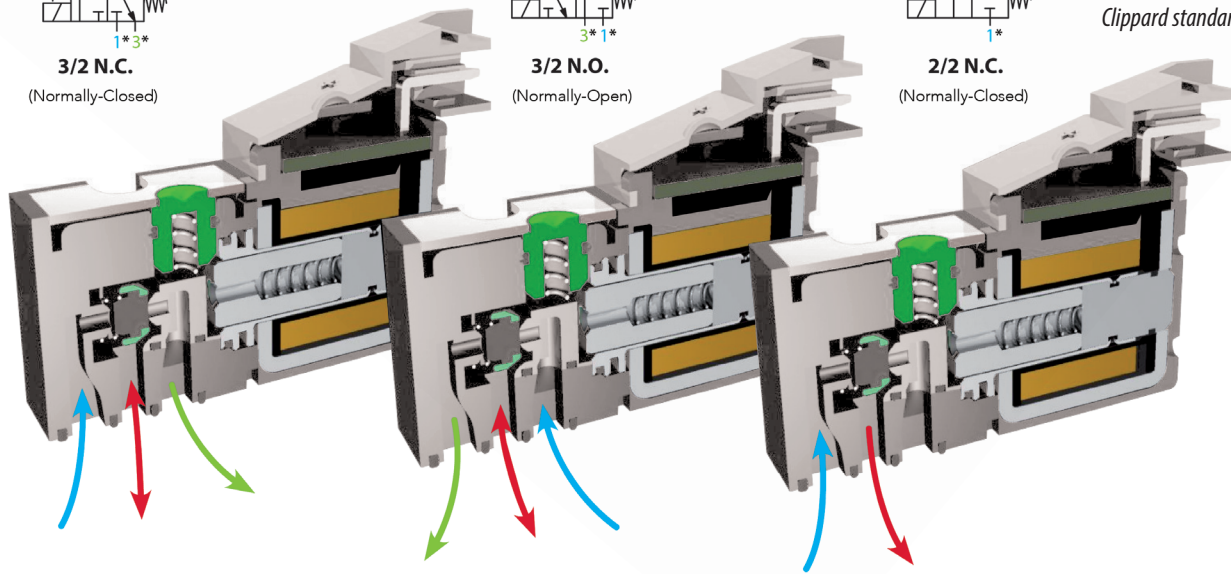

ORDERING INFORMATION

E 3 1 1 E - 3 □ □

Connectors

C In-line with LED
L 90° with LED

Voltage

012 12 VDC
024 24 VDC

Example Part Number:

E311E-3C012

For more info, scan the
QR code or visit
clippard.com/link/10mm



E2S SERIES ISOLATION VALVES

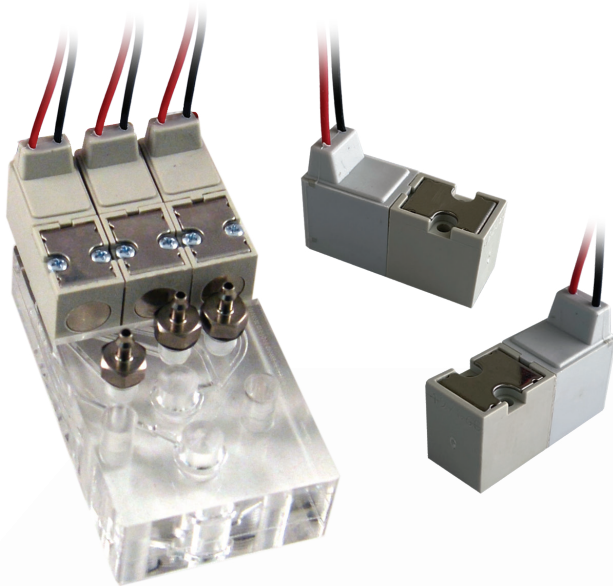

Connector	11.8" (30 cm) wire leads
Flow Range	15 to 30 l/min
Function*	2-way normally-closed isolation (<i>monodirectional</i>)
Material, Body	Nylon
Material, Seals	EPDM
Material, Wetted	Glass-filled nylon, EPDM
Max. Flow	30 l/min
Max. Temperature of Coil	311°F (155°C)
Medium	Air, water, gas, or compatible fluids
Mount	M2x14
Operating Pressure Range	0 to 36 psig (2.5 bar)
Operating Temperature Range	14 to 122°F (-10 to 50°C) <i>Must use clean, dry air when <32°F (0°C)</i>
Response Time	6 ms
Voltage	12 to 24 VDC
Wattage	1.3 to 2.8 watts
More Details	clippard.com/link/e2s

*Always less than 2 psig (0.1 bar) backpressure on outlet port for proper function.

The E2S series valve combines the versatility of Clippard's compact 10 mm valve line with the advantages of media isolation. With a durable, glass-filled nylon body and an EPDM diaphragm that separates the actuation mechanism from the flow path, the E2S series is an excellent choice for dispensing a wide range of aggressive gases and liquids in applications that require compact, electronically-controlled valves which have minimal backpressure. Applications include printing equipment, medical diagnostic devices, dental equipment, fermentation, water treatment, dispensing, and more.

Customization Options

- Voltage
- Power
- Electrical Connectors
- IP Protection
- Pressures
- Silent operation for quiet environments

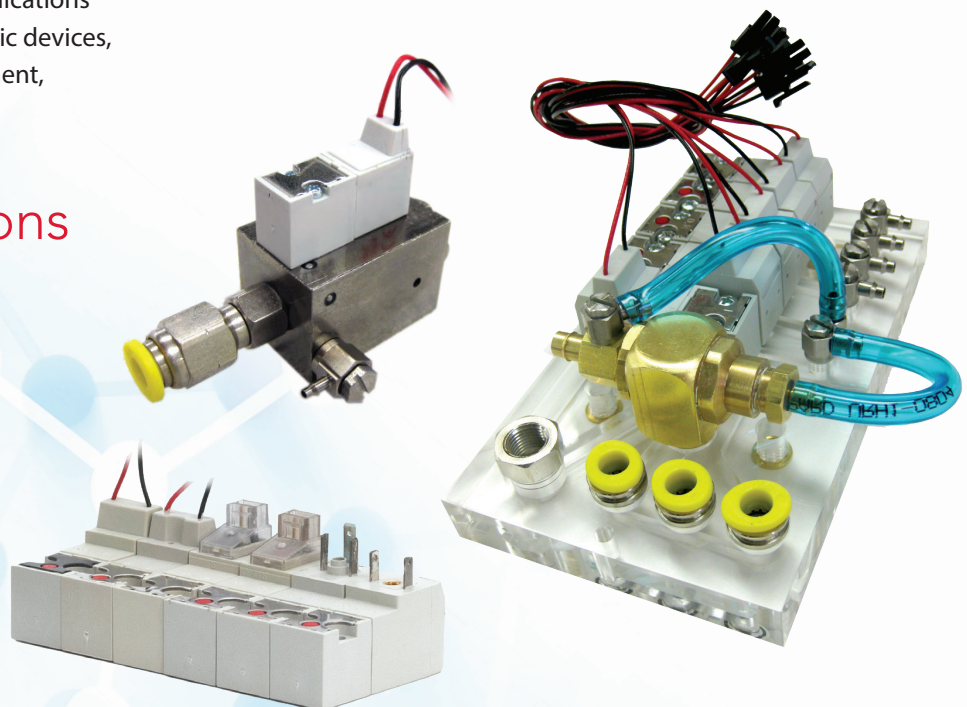

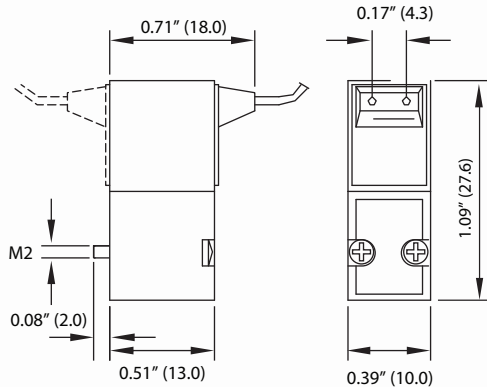

Suggested Subbase

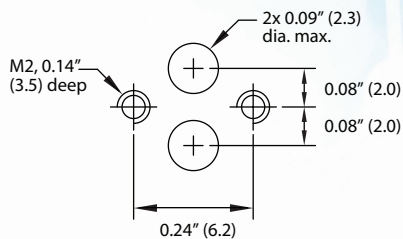

Pneumatic Interface

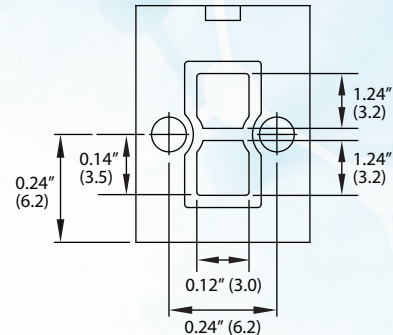

2-Way Monodirectional

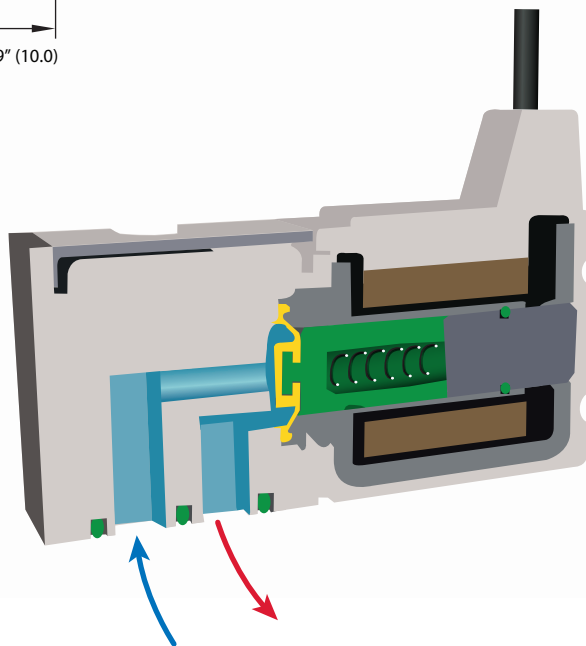
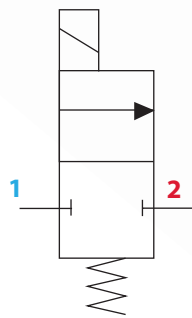

Dimensions shown are in inches (millimeters listed in parentheses).

Visit clippard.com for more detailed 2D and 3D drawings.

ORDERING INFORMATION

E 2 S 1 0 □ W □

Orifice and Wattage

- C-2 0.03" (0.8 mm), 1.3 watts—15 l/min @ 36 psig (2.5 bar)
- F-4 0.05" (1.2 mm), 2.0 watts—30 l/min @ 36 psig (2.5 bar)
- H-4 0.06" (1.4 mm), 2.0 watts—18 l/min @ 15 psig (1 bar)
- J-5 0.06" (1.6 mm), 2.8 watts—22 l/min @ 15 psig (1 bar)

Voltage

- 012 12 VDC
- 024 24 VDC

Example Part Number:

E2S10C-2W012

For more info, scan the QR code or visit clippard.com/link/e2s



15 MM STANDARD SERIES

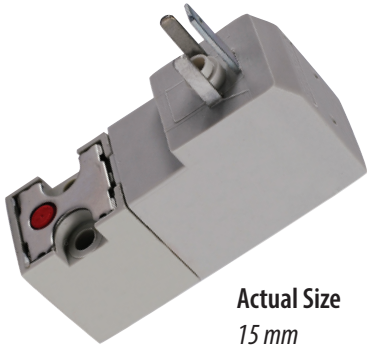

Actual Size
15 mm
with DIN connector

Clippard's line of 10 and 15 mm valves are perfect for applications where compact, electronically-controlled pneumatics are needed. Available in normally-open or normally-closed versions, these 2-way and 3-way valves feature a high strength, lightweight glass-filled nylon body and are suitable for a broad range of uses. With exceptional cycle life and reliability, this versatile miniature valve is a smart choice for applications across many different industries.

TYPICAL FLOW

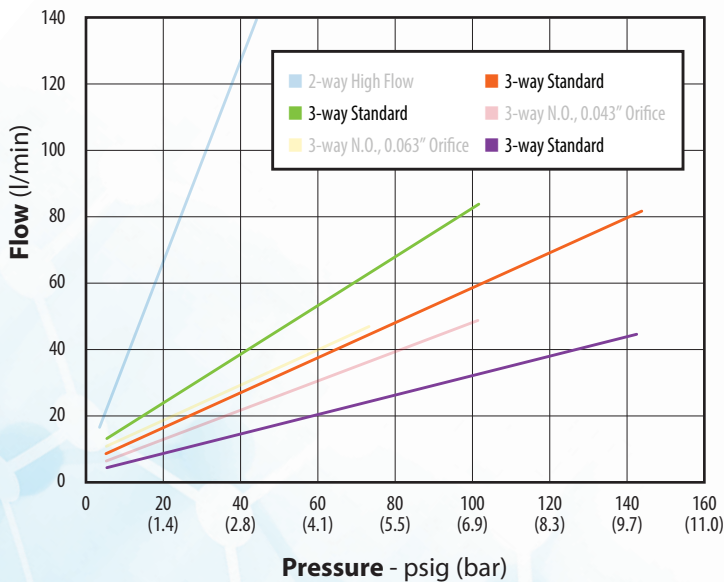

Coil Insulation Class	H 356°F (180°C) / F 311°F (155°C)
Connector	Terminal Connector DIN Connector In-Line Connector with LED 90° Connector with LED Wire Leads
Function	2-way normally-closed, 3-way normally-open or normally-closed
Manifold	Standard (See pp. 20-21 in brochure)
Material	Stainless steel core and springs, nylon body, ENP brass, FKM dynamic seals, nitrile gasket and static seals
Max. Flow	84 l/min @ 145 psig (10 bar)
Medium	Air, gas, or other compatible fluids
Mount	M3 screws (x2)
Nominal Orifice Size	0.032" Orifice: 44 l/min @ 145 psig (10 bar) 0.043" Orifice: 84 l/min @ 145 psig (10 bar) 0.063" Orifice: 45 l/min @ 72 psig (5 bar)
Operating Pressure Range	0 to 145 psig (10 bar) <i>Consult Clippard for different pressures</i>
Operating Temperature Range	14 to 122°F (-10 to 50°C) <i>If below 32°F (0°C), must use clean, dry air</i>
Power Consumption	0.032" Orifice: 1 watt 0.043" Orifice: 2 watts 0.063" Orifice: 2.5 watts
Response Time	0.032" Orifice: 8 ms nominal 0.043" Orifice: 6 ms nominal 0.063" Orifice: 6 ms nominal
Voltage	12 or 24 VDC; 24, 110, or 220 VAC
Voltage Tolerance	±10%
More Details	clippard.com/link/15mm

90° Connector with LED

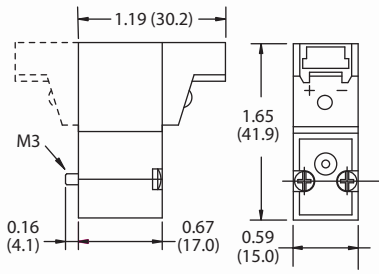

In-Line Connector with LED

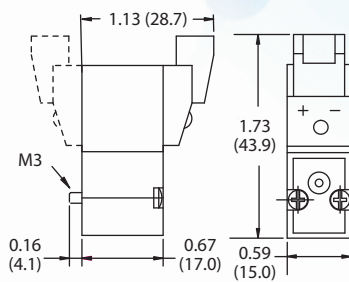

Suggested Manifold Dimension

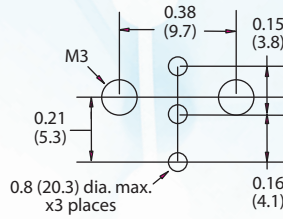

Pneumatic Interface

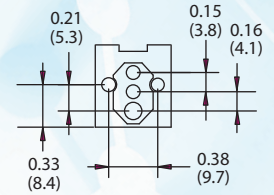

Wire Leads

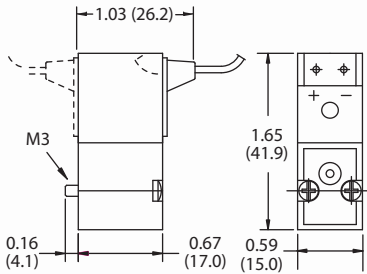

DIN Connector 43650 Form C

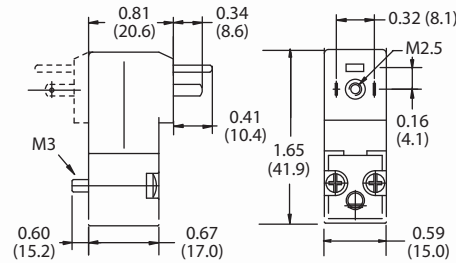

Terminal Connector (Ind. Form)

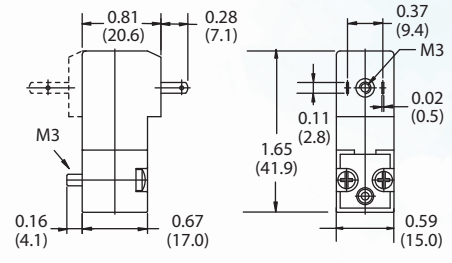

Dimensions shown are in inches (millimeters listed in parentheses). Visit clippard.com for more detailed 2D and 3D drawings.

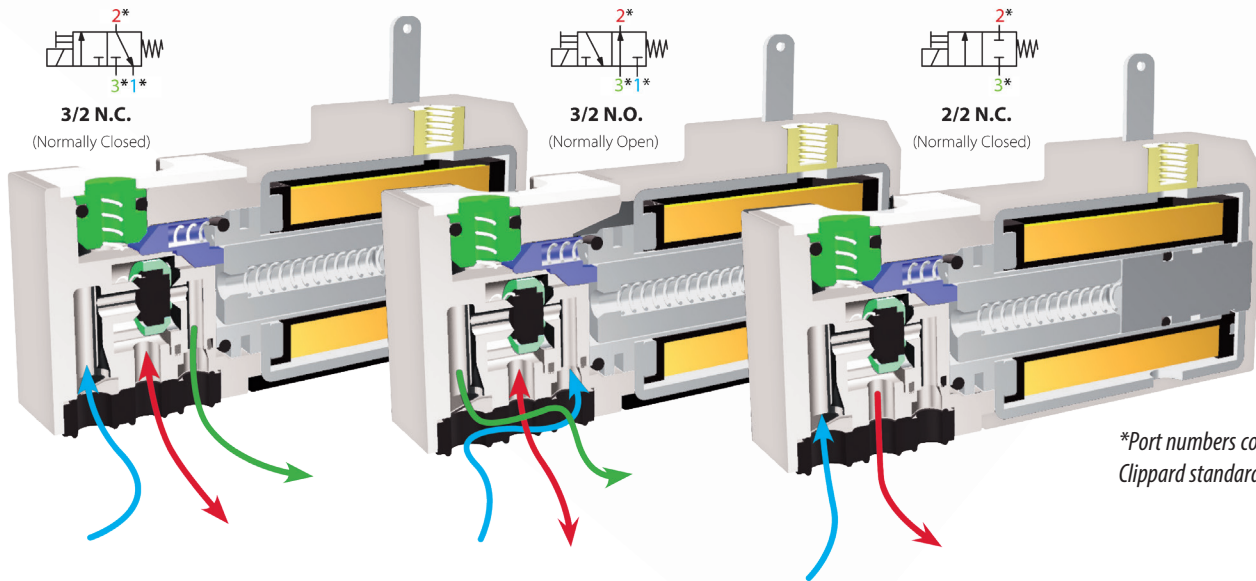

*Port numbers correspond to Clippard standard manifolds

ORDERING INFORMATION

E	1	5	-	1	1
Valve Type	Orifice	Connectors		Voltage	
2 2-way	D 0.032" (0.8 mm)	C In-line with LED		012 12 VDC	
3 3-way	E 0.043" (1.1 mm)	L 90° with LED		024 24 VDC	
3O 3-way NO	F 0.063" (1.6 mm)	W Wire Leads (11.8")		24A 24 VAC	
		T Terminal Industrial Connector		110 110 VAC	
		D DIN Form C		220 220 VAC	

Example Part Number:
E215D-1C012

For more info, scan the QR code or visit clippard.com/link/15mm



15 MM LATCHING SERIES



Actual Size
15 mm
with wire lead



Latching valves consume less energy and produce less heat than standard solenoid valves when used in extended duty cycle applications, since the coil is energized for only a small fraction of the total duty cycle. A short pulse of current opens the valve, which “latches” open indefinitely after the current stops. A subsequent pulse of current in the opposite direction closes the valve.

Coil Insulation Class	H 356°F (180°C) / F 311°F (155°C)
Connector	Wire Leads
Function	2-way or 3-way normally-closed
Manifold	Standard (See pp. 20-21 in brochure)
Material	Stainless steel core and springs, nylon body, ENP brass, FKM dynamic seals, nitrile gasket and static seals
Max. Flow	84 l/min @ 145 psig (10 bar)
Medium	Air, gas, or other compatible fluids
Mount	M3 screws (x2)
Nominal Orifice Size	0.043" Orifice: 84 l/min @ 145 psig (10 bar) 0.063" Orifice: 73 l/min @ 100 psig (7 bar)
Operating Pressure Range	0 to 145 psig (10 bar) <i>Consult Clippard for different pressures</i>
Operating Temperature Range	23 to 122°F (-5 to 50°C) <i>If below 32°F (0°C), must use clean, dry air</i>
Power Consumption	4.0 watts
Response Time	10 ms nominal
Voltage	12 or 24 VDC; 24, 110, or 220 VAC
Voltage Tolerance	±10%
More Details	clippard.com/link/15mm

TYPICAL FLOW

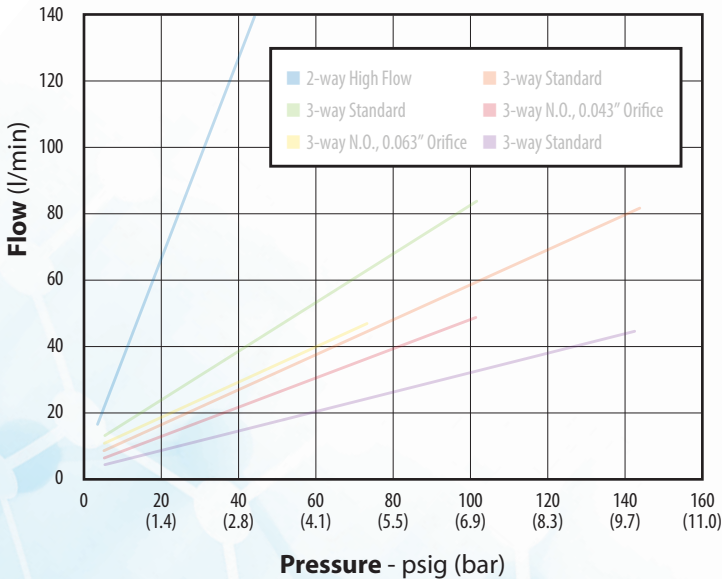

Wire Leads

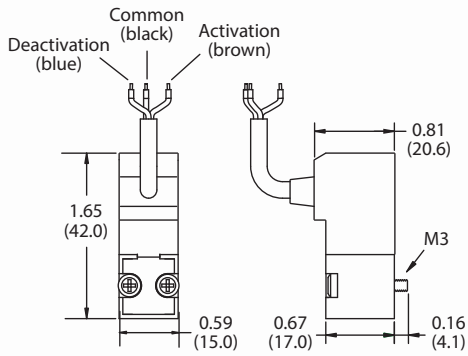

Suggested Manifold Dimension

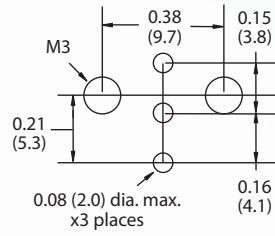

Pneumatic Interface

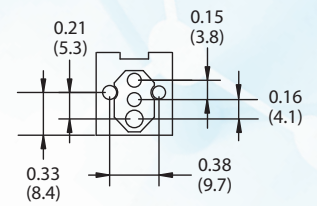

Dimensions shown are in inches (millimeters listed in parentheses).
Visit clippard.com for more detailed 2D and 3D drawings.

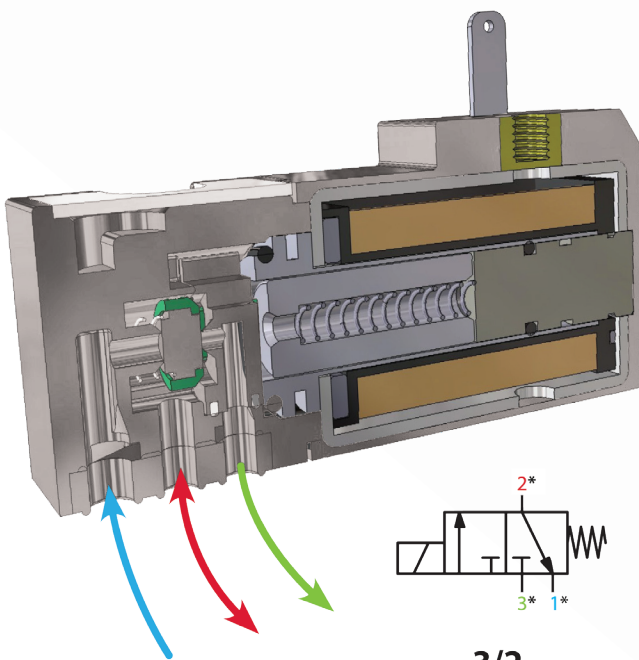

3/2

*Port numbers correspond to Clippard standard manifolds

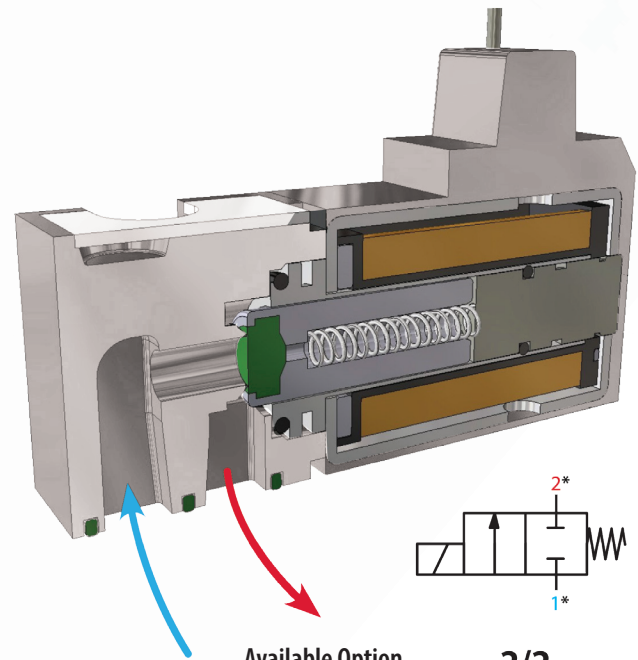



**Available Option
(not standard)**

2/2

ORDERING INFORMATION

E 
Valve Type
2 2-way
3 3-way

1 5 
Orifice
E 0.043" (1.1 mm)
F 0.063" (1.6 mm)

- 1 W 
Voltage
012 12 VDC
024 24 VDC
24A 24 VAC
110 110 VAC
220 220 VAC

Example Part Number:
E215E-1T012

For more info, scan the
QR code or visit
clippard.com/link/15mm



15 MM HIGH FLOW SERIES



Actual Size
15 mm
with in-line connector

Clippard's High Flow Series valves are designed for high flow, low pressure applications. Available in normally-closed versions, these 2-way valves feature a high strength, lightweight glass-filled nylon body and are suitable for a broad range of uses. With exceptional cycle life and reliability, this versatile miniature valve is a smart choice for applications in many industries.

TYPICAL FLOW

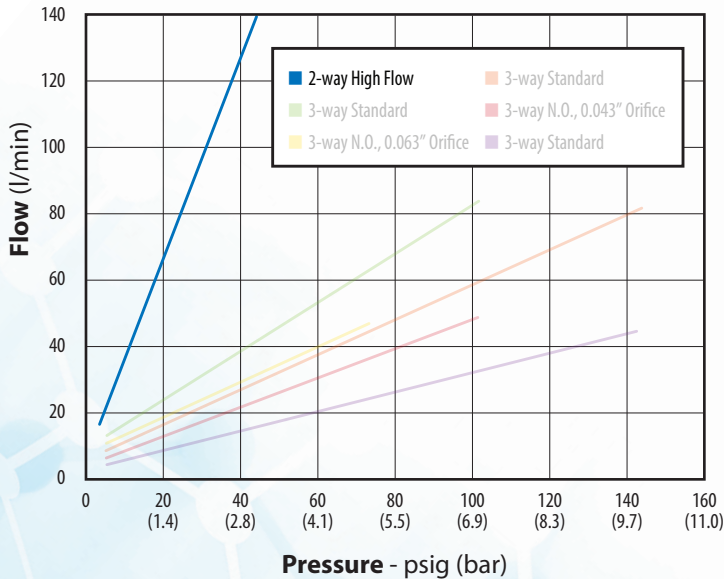

Coil Insulation Class	H 356°F (180°C) / F 311°F (155°C)
Connector	In-Line Connector with LED 90° Connector with LED
Function	2-way normally-closed monodirectional
Manifold	Standard (See pp. 20-21 in brochure)
Material	Stainless steel core and springs, nylon body, ENP brass, FKM dynamic seals, nitrile gasket and static seals
Max. Flow	140 l/min @ 50 psig (3.4 bar)
Medium	Air, gas, or other compatible fluids
Mount	M3 screws (x2)
Nominal Orifice Size	0.118" (3.0 mm)
Operating Pressure Range	0 to 50 psig (3 bar) Consult Clippard for different pressures
Operating Temperature Range	23 to 122°F (-5 to 50°C) If below 32°F (0°C), must use clean, dry air
Power Consumption	4.0 watts
Response Time	10 ms nominal
Voltage	12 or 24 VDC; 24, 110, or 220 VAC
Voltage Tolerance	±10%
More Details	clippard.com/link/15mm

90° Connector with LED

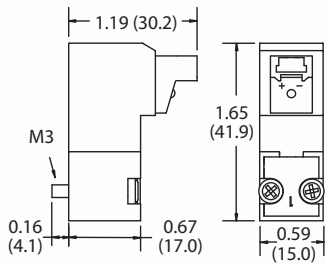

In-Line Connector with LED

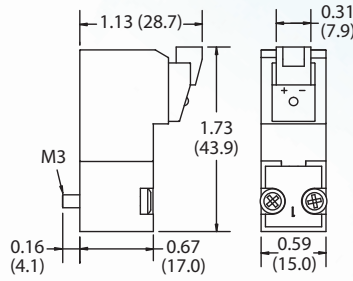

Dimensions shown are in inches
(millimeters listed in parentheses).

Visit clippard.com for more detailed
2D and 3D drawings.

Suggested Manifold Dimension

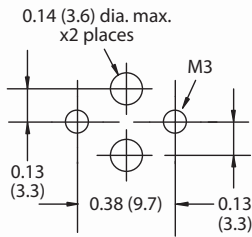

Pneumatic Interface

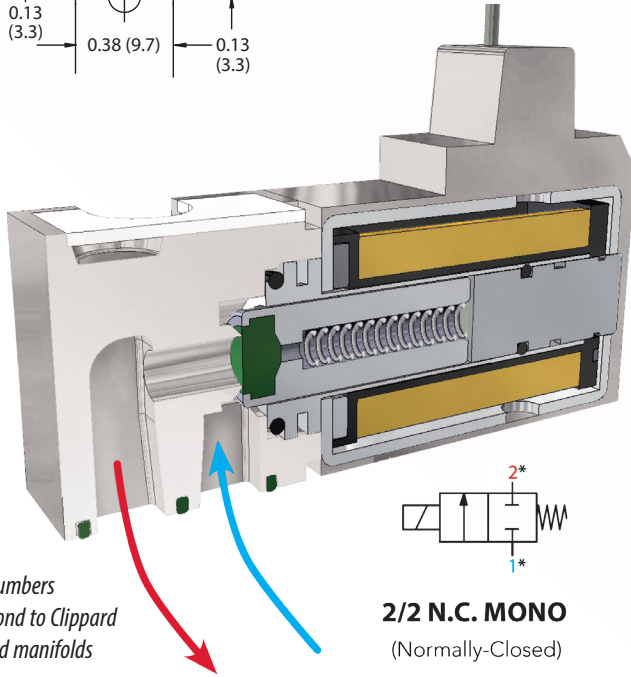
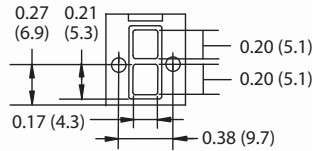

*Port numbers
correspond to Clippard
standard manifolds

2/2 N.C. MONO
(Normally-Closed)

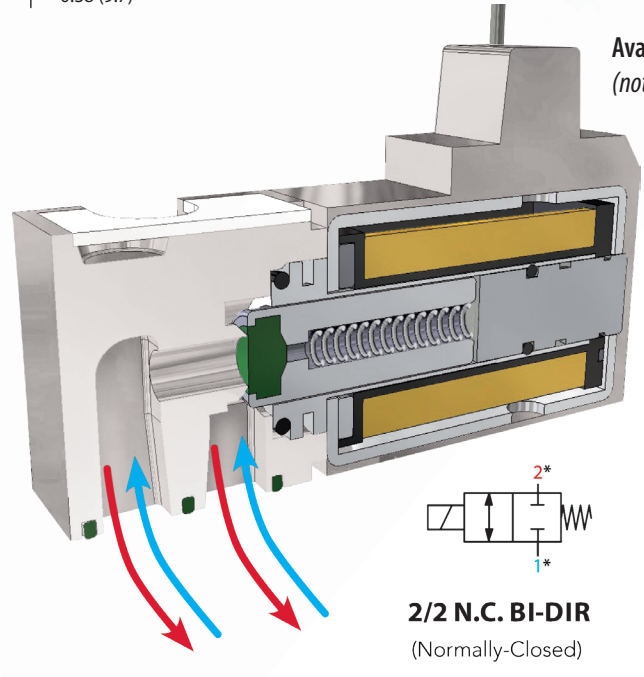

Available Option
(not standard)

2/2 N.C. BI-DIR
(Normally-Closed)

ORDERING INFORMATION

E 2 1 5 H - 3

Connectors

C In-line with LED
L 90° with LED

Voltage

012 12 VDC

024 24 VDC

Example Part Number:

E215D-1T012

For more info, scan the
QR code or visit
clippard.com/link/15mm



ACCESSORIES

MANIFOLDS

Clippard manifolds provide efficient grouping of 10 or 15 mm valves and enable quick, easy installation. Spare hardware and cover plates are also available. Each manifold features a common inlet, individually-ported outlets, and exhaust to atmosphere.

Scan QR code or visit clippard.com/link/10-15mm-acc to select manifolds and accessories, configure valves, view specs, download 3D files and more.



ORDERING INFORMATION

E M -	# of Stations
Valve	01
10 10 mm	02
10H 10 mm High Flow*	04
10L 10 mm ISO 15218*	06
15 15 mm	08
15H 15 mm High Flow*	10
	12
	14
	16

Example Part Number:
E10M-01

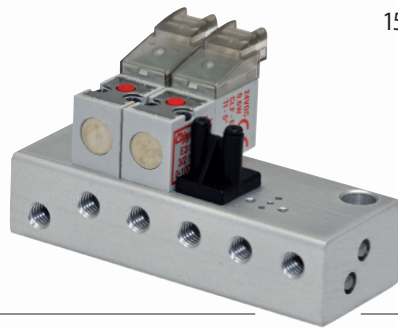

B P -	# of Barbs
Valve	2HV 2 barbs
10 10 mm	3SV 3 barbs
15 15 mm	

Example Part Number:
BP10-2HV

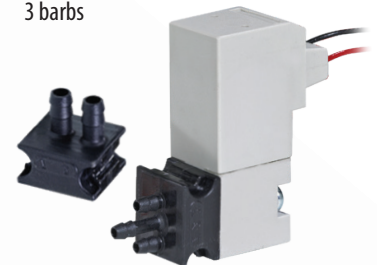

When using these multi-station manifolds with N.O. valve configurations, they cannot be used with N.C. valves on the same manifold.

DIN CONNECTORS

For use with 15 mm valves only

Form C connectors with 8 mm spade center spacing mate with DIN connector coil. Industrial Form connectors with 9.4 mm spade center spacing connect to terminal coils. Available with or without surge suppression and PVC molded three-wire cord set.

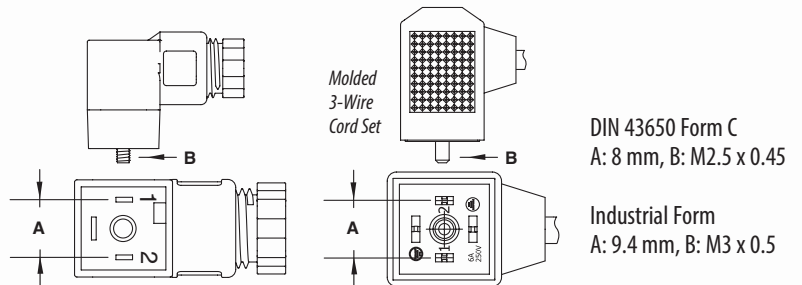

ORDERING INFORMATION

CC -	Cord
Form Part No.	Blank None
C Form C	-P6 6' cord
I Industrial Form	-P15 15' cord
Options	
Blank 6-240 Volts without LED	
LL 6-24 Volts with LED	
LM 48-110 Volts with LED	

Example Part Number:
CC-CLL-P6

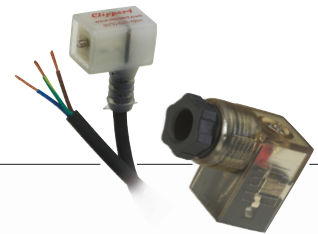

CONNECTORS

Wire connector must be ordered separately. 24 AWG, stranding 7/32. Molex #50212-8000, #28139 plug.

COVER PLATES

Includes plate, gasket and two screws.

Part No.	Description
C2A-RB300	Connector with Cable, 11.8"
C2A-RB500	Connector with Cable, 19.7"
C2A-RB1000	Connector with Cable, 39.4"



Part No.	Description
E10M-CP	10 mm Cover Plate
E15M-CP	15 mm Cover Plate



**Standard
Single-Station
Manifolds**

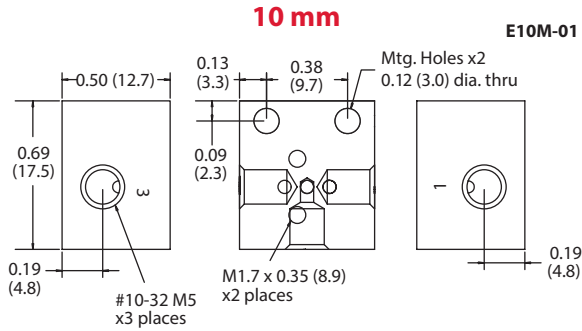

**High Flow
Single-Station
Manifolds**

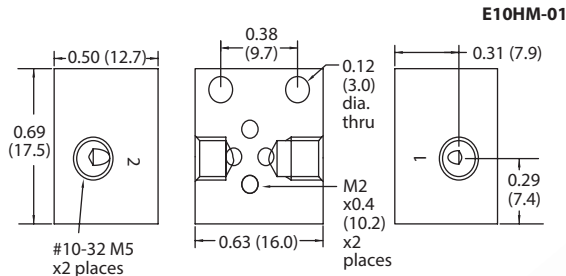

**ISO 15218
Single-Station
Manifold**

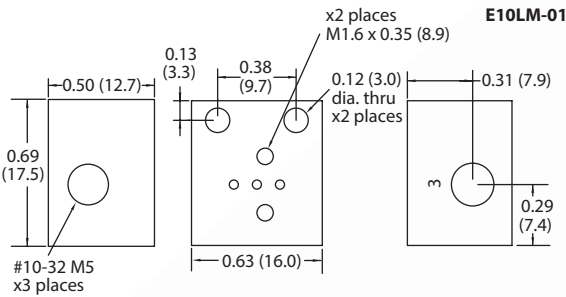

**2- to 8-Station
Manifolds**

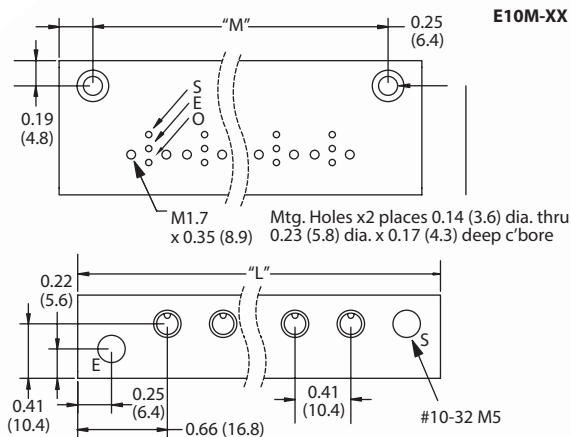

**10- to 16-Station
Manifolds**

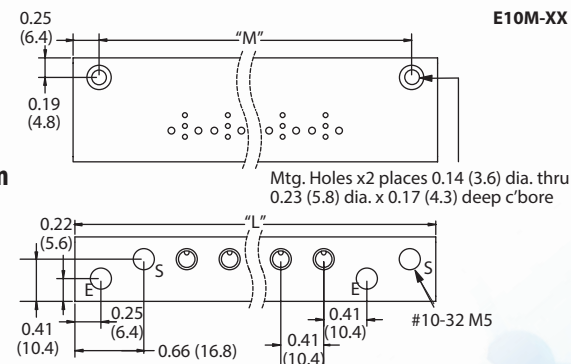

15 mm

E15M-01

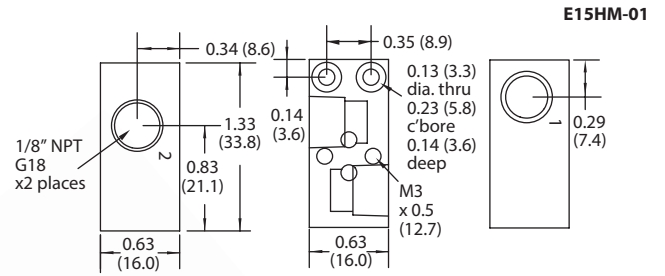
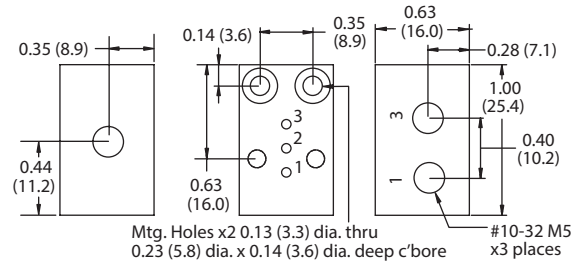

Stations	10 mm		15 mm	
	L	M	L	M
2	1.74 (44.2)	1.24 (31.5)	2.95 (74.9)	2.55 (64.8)
4	2.57 (65.3)	2.07 (52.6)	4.21 (106.7)	3.81 (96.8)
6	3.39 (86.1)	2.89 (73.4)	5.47 (137.2)	5.07 (128.8)
8	4.22 (107.2)	3.72 (94.5)	6.73 (170.9)	6.33 (160.8)
10	5.87 (149.1)	5.37 (136.4)	9.25 (235.0)	8.85 (224.8)
12	6.70 (170.2)	6.20 (157.5)	10.51 (267.0)	10.1 (256.5)
14	7.52 (191.0)	7.02 (178.3)	11.77 (297.2)	11.4 (289.6)
16	8.35 (212.1)	7.85 (199.4)	13.03 (331.0)	12.6 (320.0)

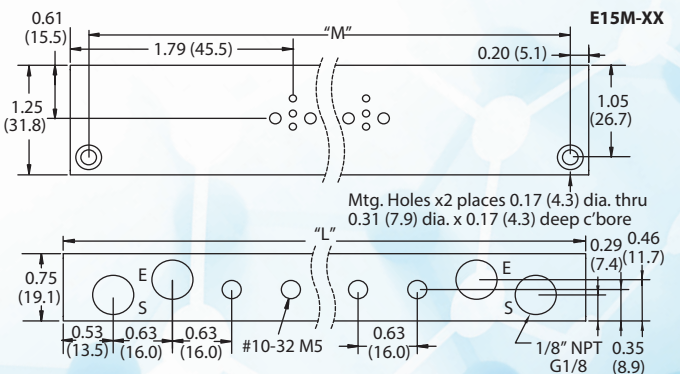
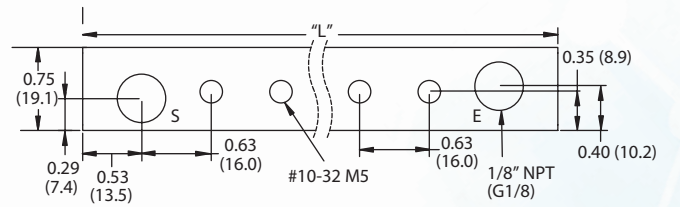
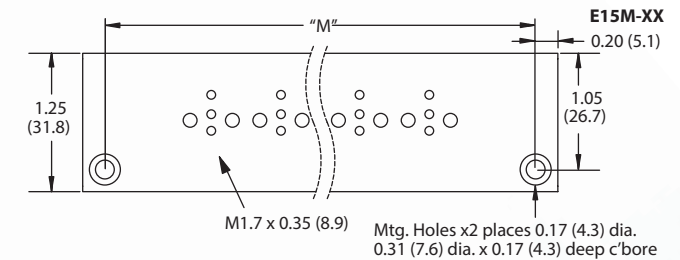

PRECISION CONTROL SOLUTIONS



ELECTRONIC VALVES

Clippard revolutionized the electronic valve market in the early 1970s with the EV series, which quickly became the industry standard for life and reliability. This unparalleled history in providing new and innovative products continues today, aided by advanced manufacturing machines and techniques.

clippard.com/link/elec-valves

PROPORTIONAL VALVES

For optimal controllability, proportional valves provide output proportional to input. These types of valves are ideal for applications which require variable flow control.

clippard.com/link/prop-valves

ISOLATION VALVES

Media isolation valves are used for a wide variety of applications, including those that require precise, repeatable dispensing for medical and analytical instrumentation. Choose from a large variety of sizes, configurations, materials, and options or contact us to discuss special customizations.

clippard.com/link/isolation-valves



CONTROL VALVES

From flow controls to needle valves, check valves, shuttle valves, exhaust valves and more, Clippard's control valves are available in a wide range configurations and functions. Sizes range from #3-56 and #10-32 through 3/8" NPT, for pressures up to 300 psig.

clippard.com/link/control-valves

DIRECTIONAL CONTROL VALVES

Clippard's line of mechanically-operated directional control valves includes toggle, stem, and lever valves as well as hand and foot-actuated pedal valves, palm button valves, and more. Choose from #3-56, #10-32, 1/8" NPT or 1/4" NPT ports.

clippard.com/link/directional-valves

AIR PILOT VALVES

The force output of an air pilot is much more powerful than the power produced from electrical solenoids or actuators. This makes air pilot valves ideal for applications where higher air flow and/or lower power are required, as well as when simplicity and cost savings are important.

clippard.com/link/air-pilot-valves



ELECTRONIC CONTROLS

Clippard's Cordis series is a highly-customizable line of electronic controls designed to help close the loop around pressure and flow. With unparalleled accuracy and resolution, this line will elevate your application to the next level. Take control like never before with the Cordis.

clippard.com/link/elec-controls



PRESSURE REGULATORS

Regulators are offered in either relieving or non-relieving versions with a large variety of adjustment options and mounting styles to choose from. For even greater precision control, check out Clippard's Cordis line of electronic pressure regulators.

clippard.com/link/press-reg

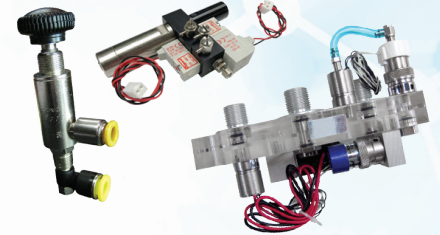

CUSTOM SOLUTIONS

Clippard excels at designing special variations, modifications, and completely custom valves, fittings, and assemblies. If you need a product that fits your application perfectly, we will work with you to design or modify products to suit your exact needs.

clippard.com/link/custom



AIR PREP EQUIPMENT

Pneumatic applications with properly conditioned air will operate longer, cost less, and improve system efficiency. Clippard's line includes filters, regulators, lubricators, and combination units from #10-32 up to 1". A modular design and interconnecting hardware simplifies installation and maintenance.

clippard.com/link/air-prep



FITTINGS

Small in size but large in performance, Clippard precision fittings are designed to save you time, space, and money when designing versatile, efficient, trouble-free circuits. Choose from an endless variety in several different styles including push-quick, slip-on, barb, and quick connect.

clippard.com/link/fittings



HOSE & TUBING

Choose from a large variety of miniature hose and tubing, including copper and nylon tubing, flexible urethane and vinyl hose and tubing, and food-, medical-, or laboratory-grade silicone tubing.

clippard.com/link/tubing

Clippard products are distributed through our worldwide network of sales and engineering specialists. All of our representatives are stocking distributors and keep a variety of Clippard products on hand to fill your immediate needs. Each of our distributors are backed by our own large inventory to ensure quick delivery.

To locate your nearest distributor, call 877-245-6247 or visit clippard.com/distributors

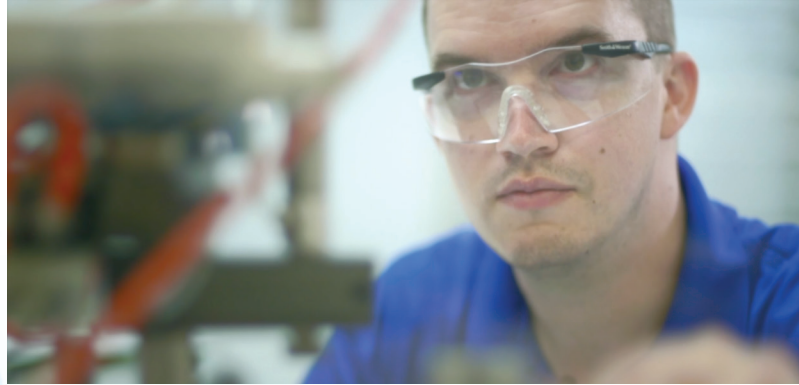

ELECTRONIC VALVES

PROPORTIONAL VALVES

ISOLATION VALVES

ELECTRONIC CONTROLS

CUSTOM SOLUTIONS

PRESSURE REGULATORS

CONTROL VALVES

DIRECTIONAL CONTROL VALVES

AIR PILOT VALVES

AIR PREPARATION EQUIPMENT

FITTINGS, HOSE, & TUBING

Clippard

United States

1-877-245-6247

Europe

+32 10-45-21-34

China

+86 137-9527-9010

DISTRIBUTED BY:



*Scan QR code or visit
clippard.com/link/request-literature
to request additional literature.*